



**20CTQ150**  
**20CTQ150S**  
**20CTQ150-1**

**SCHOTTKY RECTIFIER**

**20 Amp**





**Major Ratings and Characteristics**

Characteristics	Values	Units
$I_{F(AV)}$ Rectangular waveform	20	A
$V_{RRM}$	150	V
$I_{FSM}$ @ tp = 5 $\mu$ s sine	1030	A
$V_F$ @ 10 Apk, $T_J = 125^\circ\text{C}$ (per leg)	0.66	V
$T_J$ range	-55 to 175	$^\circ\text{C}$

**Description/ Features**

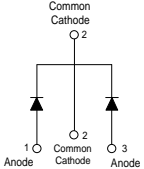
This center tap Schottky ectifier has been optimized for low reverse leakage at high temperature. The proprietary barrier technology allows for reliable operation up to 175° C junction temperature. Typical applications are in switching power supplies, converters, free-wheeling diodes, and reverse battery protection.

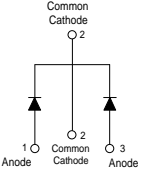
- 175° C  $T_J$  operation
- Center tap configuration
- Low forward voltage drop
- High purity, high temperature epoxy encapsulation for enhanced mechanical strength and moisture resistance
- High frequency operation
- Guard ring for enhanced ruggedness and long term reliability

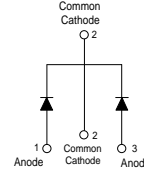
Case Styles		
<p><b>20CTQ150</b></p>  <p>Base Common Cathode O 2</p>  <p>1 O Anode    O 2 Common Cathode    O 3 Anode</p> <p><b>TO-220AB</b></p>	<p><b>20CTQ150S</b></p>  <p>Base Common Cathode O 2</p>  <p>1 O Anode    O 2 Common Cathode    O 3 Anode</p> <p><b>D<sup>2</sup>PAK</b></p>	<p><b>20CTQ150-1</b></p>  <p>Base Common Cathode O 2</p>  <p>1 O Anode    O 2 Common Cathode    O 3 Anode</p> <p><b>TO-262</b></p>

## Voltage Ratings

Parameters	20CTQ150 20CTQ150S 20CTQ150-1
$V_R$ Max. DC Reverse Voltage (V)	150
$V_{RWM}$ Max. Working Peak Reverse Voltage (V)	

## Absolute Maximum Ratings

Parameters	Values	Units	Conditions
$I_{F(AV)}$ Max. Average Forward Current (Per Leg) * See Fig. 5 (Per Device)	10	A	50% duty cycle @ $T_C = 154^\circ\text{C}$ , rectangular wave form
	20		
$I_{FSM}$ Max. Peak One Cycle Non-Repetitive Surge Current (Per Leg) * See Fig. 7	1030	A	5 $\mu\text{s}$ Sine or 3 $\mu\text{s}$ Rect. pulse
	180		10ms Sine or 6ms Rect. pulse
$E_{AS}$ Non-Repetitive Avalanche Energy (Per Leg)	2.45	mJ	$T_J = 25^\circ\text{C}$ , $I_{AS} = 0.7$ Amps, $L = 10$ mH
$I_{AR}$ Repetitive Avalanche Current (Per Leg)	0.7	A	Current decaying linearly to zero in 1 $\mu\text{sec}$ Frequency limited by $T_J$ max. $V_A = 1.5 \times V_R$ typical

## Electrical Specifications

Parameters	Typ.	Max.	Units	Conditions
$V_{FM}$ Max. Forward Voltage Drop (Per Leg) * See Fig. 1	0.80	0.88	V	@ 10A
	0.90	1.0	V	@ 20A
	0.63	0.66	V	@ 10A
	0.73	0.77	V	@ 20A
$I_{RM}$ Max. Reverse Leakage Current (Per Leg) * See Fig. 2	3.0	25	$\mu\text{A}$	$T_J = 25^\circ\text{C}$
	2.7	5.0	mA	$T_J = 125^\circ\text{C}$
$C_T$ Typical Junction Capacitance (Per Leg)	-	280	pF	$V_R = 5V_{DC}$ (test signal range 100kHz to 1Mhz) @ $25^\circ\text{C}$
$L_S$ Typical Series Inductance (Per Leg)	-	8.0	nH	Measured lead to lead 5mm from package body
dv/dt Max. Voltage Rate of Change	-	10000	V/ $\mu\text{s}$	(Rated $V_R$ )

(1) Pulse Width < 300 $\mu\text{s}$ , Duty Cycle < 2%

## Thermal-Mechanical Specifications

Parameters	Values	Units	Conditions
$T_J$ Max. Junction Temperature Range	-55 to 175	$^\circ\text{C}$	
$T_{stg}$ Max. Storage Temperature Range	-55 to 175	$^\circ\text{C}$	
$R_{thJC}$ Max. Thermal Resistance Junction to Case (Per Leg)	2.0	$^\circ\text{C}/\text{W}$	DC operation
$R_{thJC}$ Max. Thermal Resistance Junction to Case (Per Package)	1.0	$^\circ\text{C}/\text{W}$	DC operation
$R_{thCS}$ Typical Thermal Resistance, Case to Heatsink	0.50	$^\circ\text{C}/\text{W}$	Mounting surface, smooth and greased (only for TO-220)
wt Approximate Weight	2 (0.07)	g (oz.)	
T Mounting Torque	Min.	6 (5)	Kg-cm (lbf-in)
	Max.	12 (10)	
Marking Device	20CTQ150	Case style TO-220	
	20CTQ150S	Case style D <sup>2</sup> -Pak	
	20CTQ150-1	Case style TO-262	

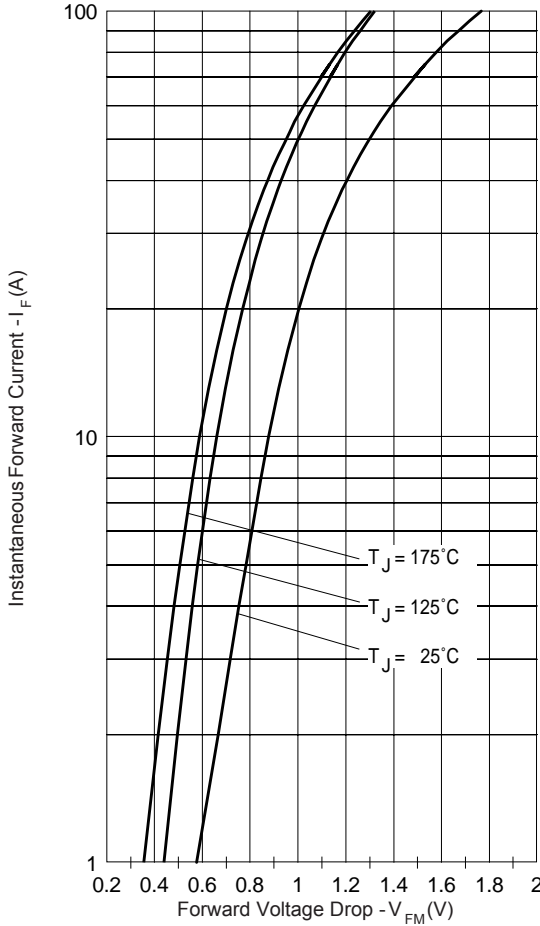

Fig. 1 - Max. Forward Voltage Drop Characteristics (Per Leg)

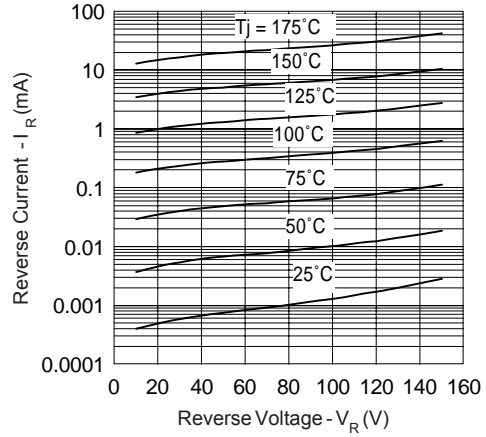

Fig. 2 - Typical Values Of Reverse Current Vs. Reverse Voltage (Per Leg)

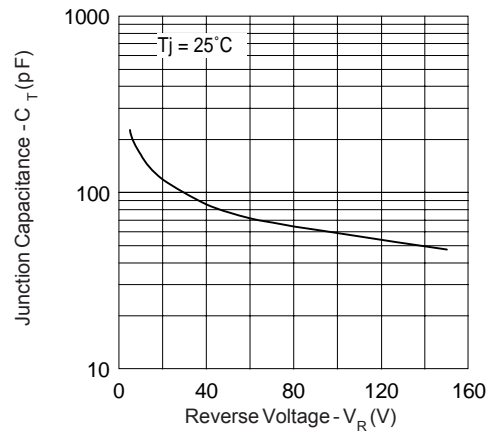

Fig. 3 - Typical Junction Capacitance Vs. Reverse Voltage (Per Leg)

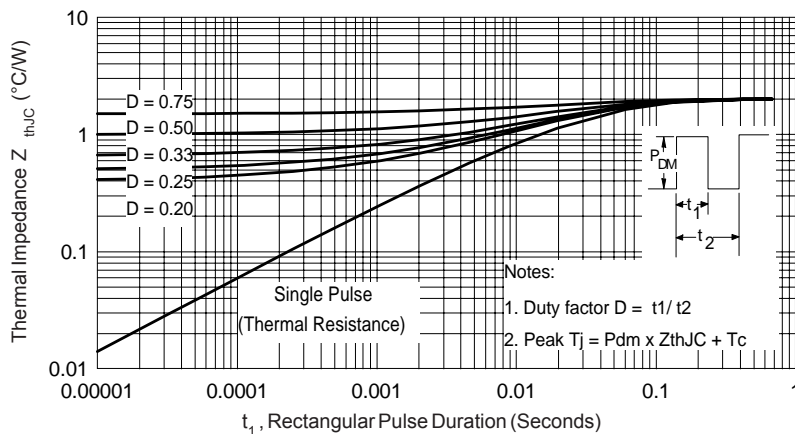

Fig. 4 - Max. Thermal Impedance  $Z_{thJC}$  Characteristics (Per Leg)

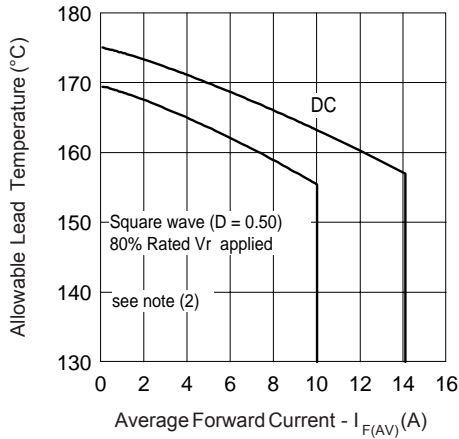

Fig. 5 - Maximum Average Forward Current Vs. Allowable Lead Temperature

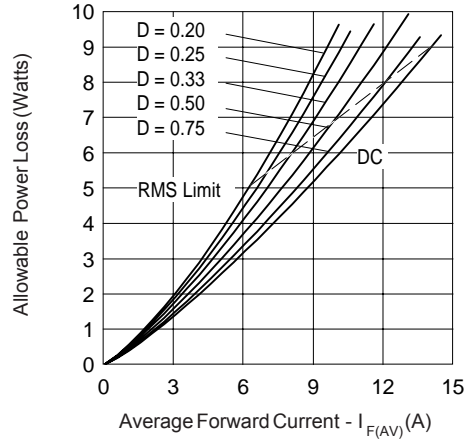

Fig. 6 - Maximum Average Forward Dissipation Vs. Average Forward Current

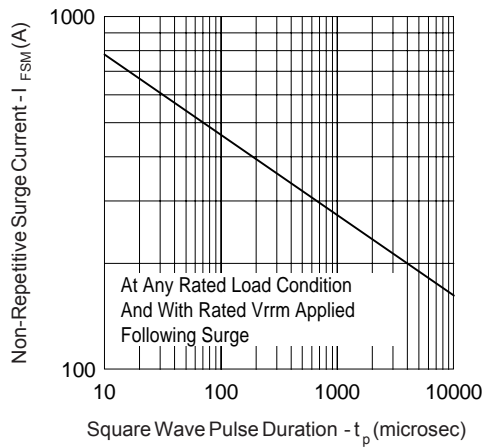

Fig. 7 - Maximum Peak Surge Forward Current Vs. Pulse Duration

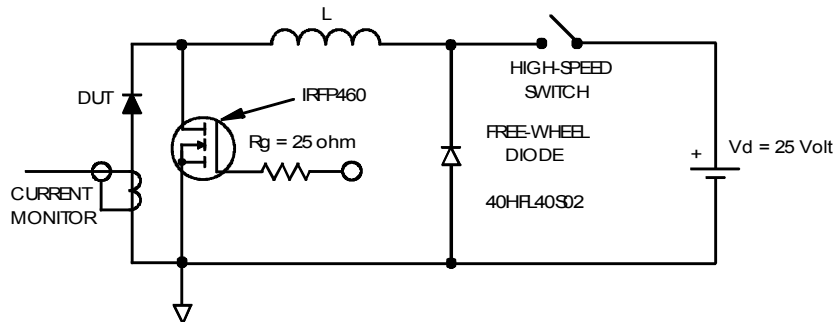
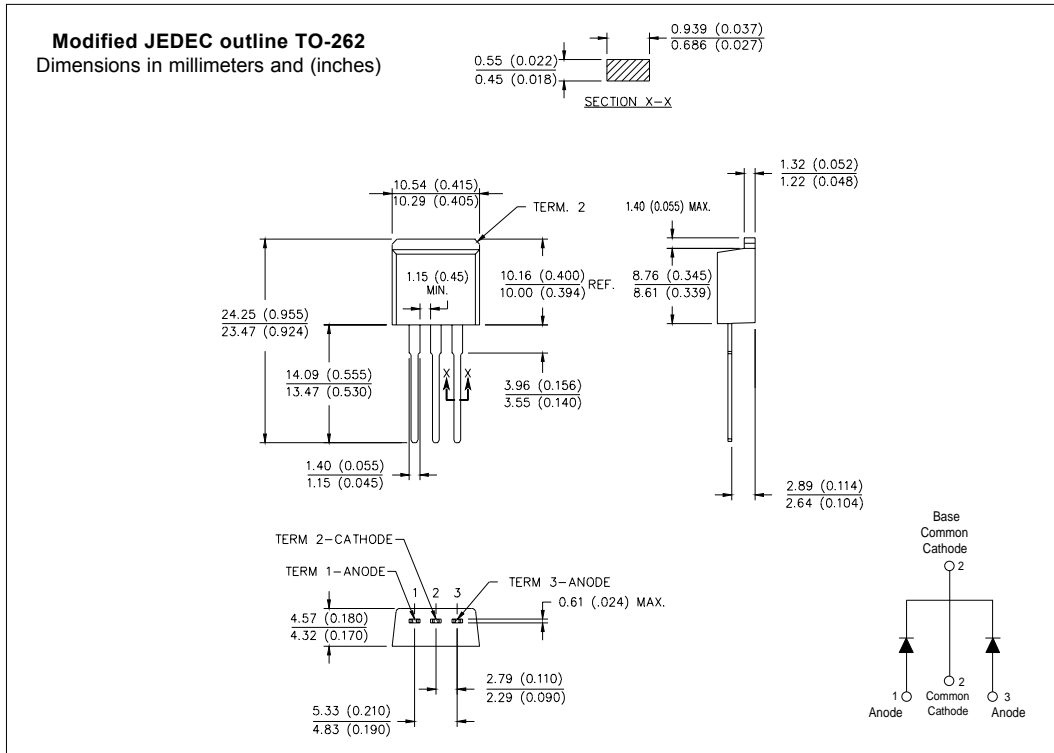
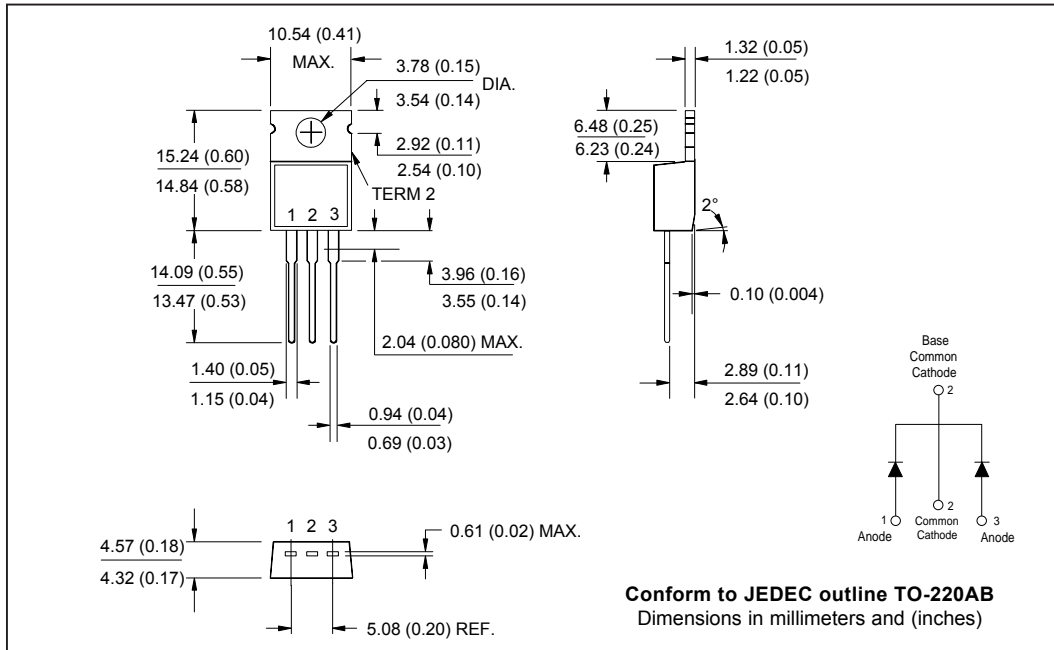

Fig. 8 - Unclamped Inductive Test Circuit

- (2) Formula used:  $T_C = T_J - (Pd + Pd_{REV}) \times R_{thJC}$ ;  
 $Pd = \text{Forward Power Loss} = I_{F(AV)} \times V_{FM} @ (I_{F(AV)} / D)$  (see Fig. 6);  
 $Pd_{REV} = \text{Inverse Power Loss} = V_{R1} \times I_R (1 - D)$ ;  $I_R @ V_{R1} = 80\% \text{ rated } V_R$

Outline Table



Outline Table

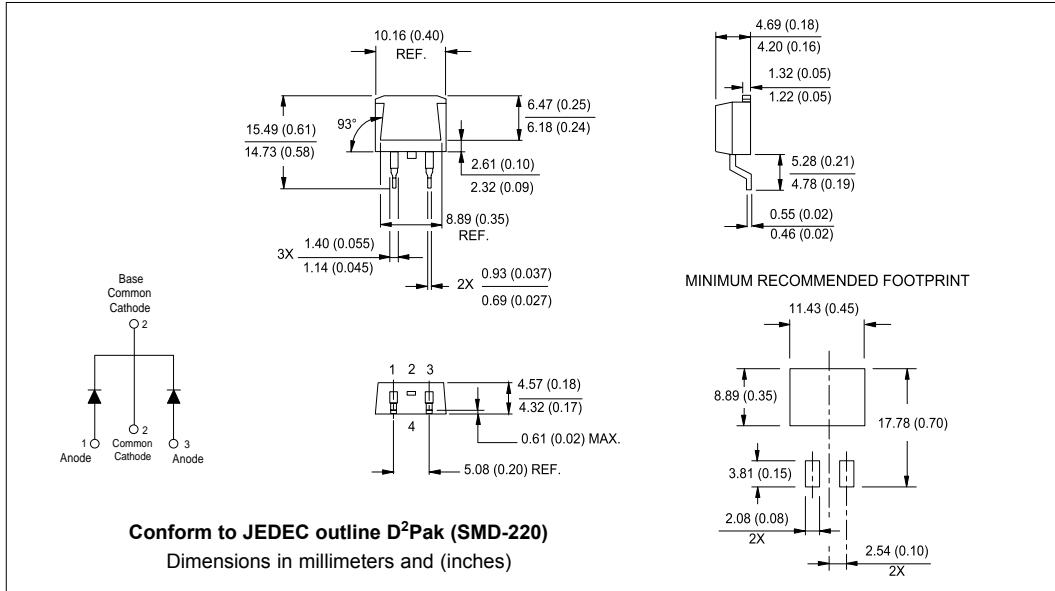

Tape & Reel Information

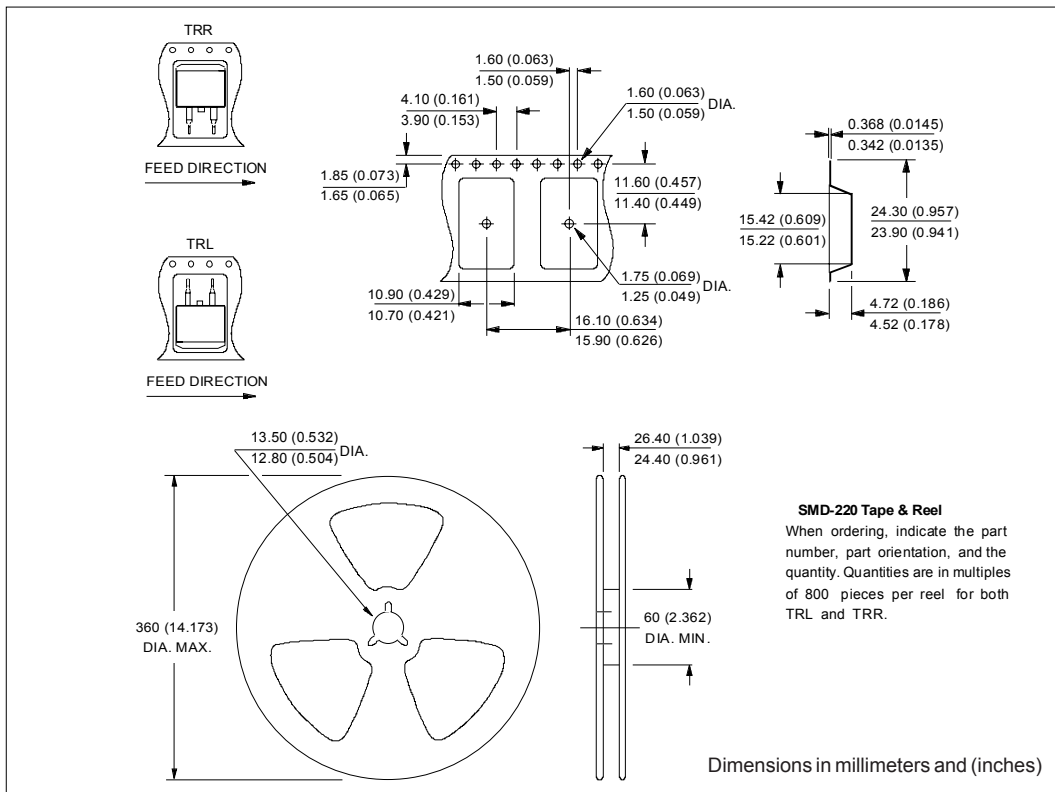

Part Marking Information

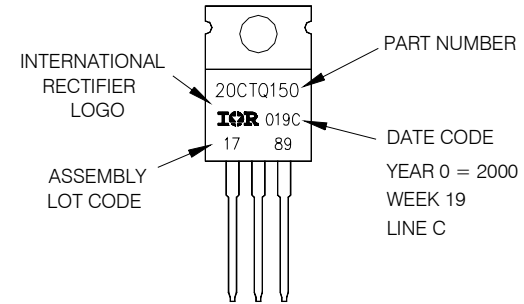
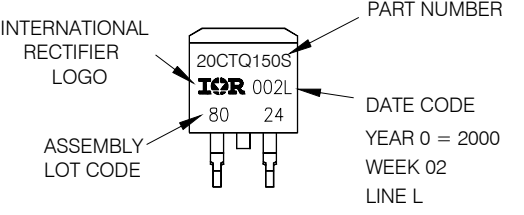
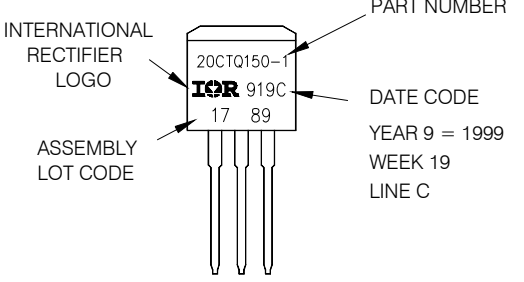
<p>EXAMPLE: THIS IS A 20CTQ150          LOT CODE 1789          ASSEMBLED ON WW 19, 2000          IN THE ASSEMBLY LINE "C"</p>	 <p>INTERNATIONAL RECTIFIER LOGO</p> <p>20CTQ150</p> <p><b>IR</b> 019C</p> <p>17 89</p> <p>PART NUMBER</p> <p>DATE CODE YEAR 0 = 2000 WEEK 19 LINE C</p> <p>ASSEMBLY LOT CODE</p>
<p>TO-220</p>	
<p>EXAMPLE: THIS IS A 20CTQ150S          LOT CODE 8024          ASSEMBLED ON WW 02, 2000          IN THE ASSEMBLY LINE "L"</p>	 <p>INTERNATIONAL RECTIFIER LOGO</p> <p>20CTQ150S</p> <p><b>IR</b> 002L</p> <p>80 24</p> <p>PART NUMBER</p> <p>DATE CODE YEAR 0 = 2000 WEEK 02 LINE L</p> <p>ASSEMBLY LOT CODE</p>
<p>D<sup>2</sup>PAK</p>	
<p>EXAMPLE: THIS IS A 20CTQ150-1          LOT CODE 1789          ASSEMBLED ON WW 19, 1999          IN THE ASSEMBLY LINE "C"</p>	 <p>INTERNATIONAL RECTIFIER LOGO</p> <p>20CTQ150-1</p> <p><b>IR</b> 919C</p> <p>17 89</p> <p>PART NUMBER</p> <p>DATE CODE YEAR 9 = 1999 WEEK 19 LINE C</p> <p>ASSEMBLY LOT CODE</p>
<p>TO-262</p>	

Ordering Information Table

Device Code	
<b>20</b>	<b>C</b>
<b>T</b>	<b>Q</b>
<b>150</b>	<b>S</b>
<b>TRL</b>	<b>-</b>
(1)	(2)
(3)	(4)
(5)	(6)
(7)	(8)
<b>1</b>	- Current Rating (20 = 20A)
<b>2</b>	- C = Common Cathode
<b>3</b>	- T = TO-220
<b>4</b>	- Q = Schottky Q Series
<b>5</b>	- Voltage Rating (150 = 150V)
<b>6</b>	- <ul style="list-style-type: none"> <li>• none = TO-220AB</li> <li>• -1 = TO-262</li> <li>• S = D<sup>2</sup>Pak</li> </ul>
<b>7</b>	- <ul style="list-style-type: none"> <li>• none = Tube (50 pieces)</li> <li>• TRL = Tape &amp; Reel (Left Oriented - for D<sup>2</sup>Pak only)</li> <li>• TRR = Tape &amp; Reel (Right Oriented - for D<sup>2</sup>Pak only)</li> </ul>
<b>8</b>	- <ul style="list-style-type: none"> <li>• none = Standard Production</li> <li>• PbF = Lead-Free</li> </ul>

Data and specifications subject to change without notice.  
This product has been designed for Industrial Level.  
Qualification Standards can be found on IR's Web site.